

- PL Instrukcja montażu
 D Aufbauanleitung
 GB Assembly instruction

ZG - BOX 81 + WS

(08-20)

⚠ UWAGA

Drogi kliencie, przed rozpoczęciem montażu upewnij się, czy posiadasz wszystkie niezbędne elementy pokazane w instrukcji.

W przypadku zamówienia mebla tapicerowanego tkaniną w takim samym kolorze jak zakupione wcześniej meble, może wystąpić różnica w odcieniach wybranej tkaniny.

⚠ ACHTUNG

Sehr geehrter Kunde. Bitte überprüfen Sie vor Beginn der Montage die Vollständigkeit unten aufgeführten Bauteile.

Bei einer Nachbestellung dieser Artikel können Farbabweichungen bei den gewählten Stoffen sein.

⚠ CAUTION

Dear Customer, before assembly, ensure that you have all the necessary elements specified in the instruction.

In case of ordering the same fabric in different time, the colour of fabric may be a little bit different.

Oznaczenia kontrolne
 Bezeichnungen steuern
 Control marks

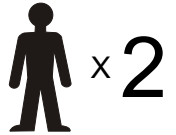



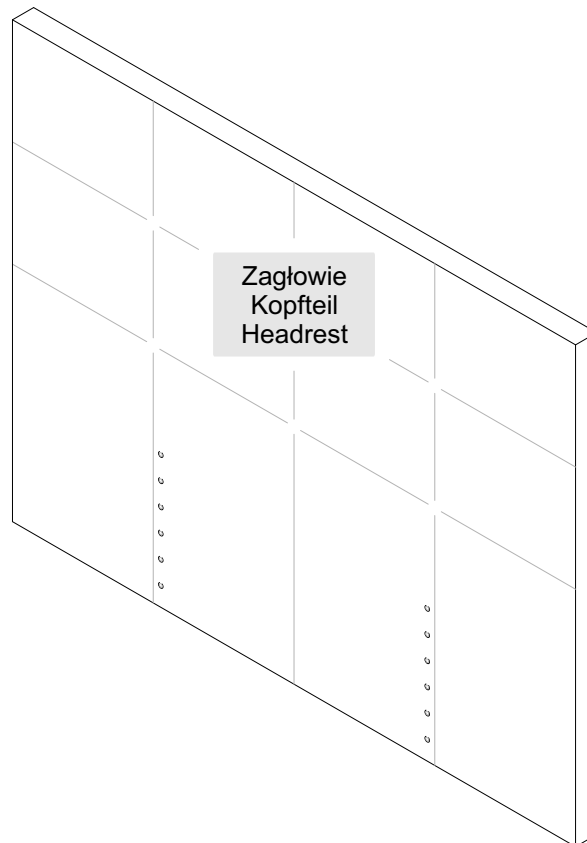

Elementy w paczkach
 Befestigungsmaterial im Paket
 Items in the packages

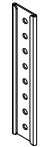
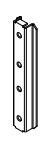

Nr	Indeks	Szt.
1	X-B81-ZG....	1

Elementy w worku serwisowym
 Befestigungsmaterial im Servicebeutel
 Items in bag service

X_B87-ZG-WS

A	B	C	D	E
 WSUWKA-MB-02	 WSUWKA-MB-01	 M6 x 60	 M6 x 25	 4
2 x	2 x	4 x	8 x	1 x

Dodatkowe elementy niezbędne do sprawnego montażu
 Zusätzliche Komponenten für eine reibungslose Installation
 Additional components needed for a smooth assembly

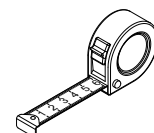

Instrukcja montażu - Aufbauanleitung - Assembly instruction

UWAGA - Mocując element **B** do korpusu / ramy **KSP KSP 2 RR 97 B 0097 BZ B 0147 BZ** zastosuj element (śrubę) **D**. Do pozostałych modeli korpusów / ram zastosuj element (śrubę) **C**.



ACHTUNG - Bei Befestigung Element **B** an den Körper / Rahmen **KSP KSP 2 RR 97 B 0097 BZ B 0147 BZ** verwende Element (Schraube) **D**. Für andere Körpermodelle / Rahmen verwende noch gebliebene Teile (Schraube) **C**.

CAUTION - When fixing element **B** to the frame **KSP KSP 2 RR 97 B 0097 BZ B 0147 BZ** use element (screw) **D**. To the rest of the frames please use the element (screw) **C**.

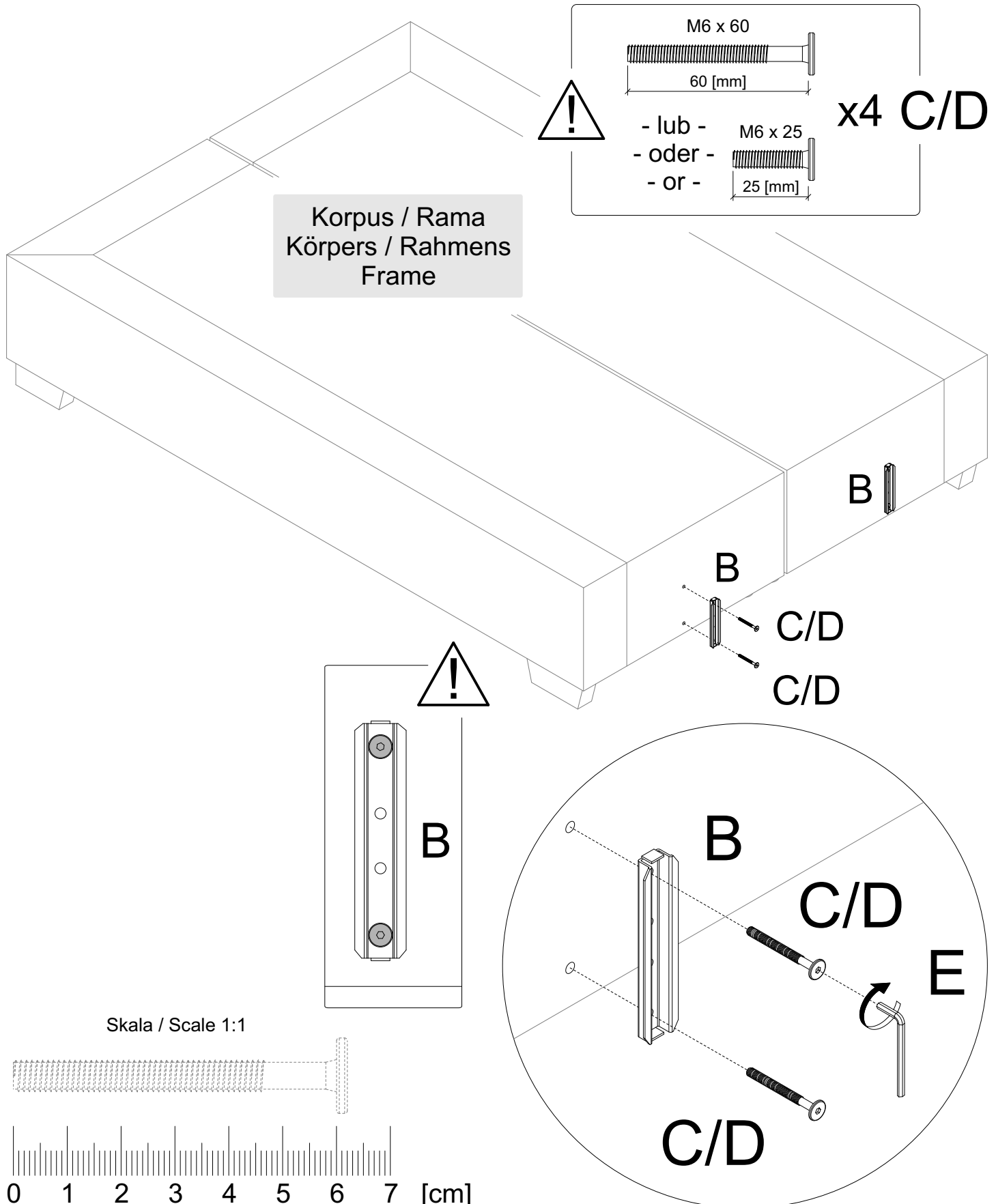

Skala / Scale 1:1

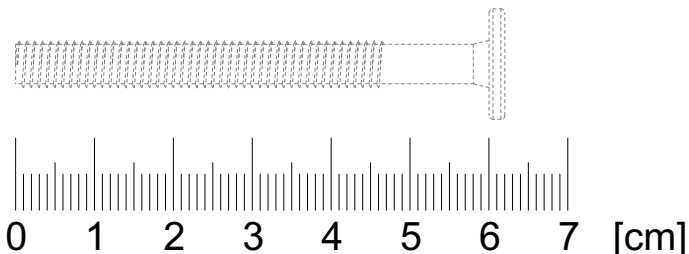

UWAGA - Dostosuj wysokość mocowania elementu **A** na zagłowie do wysokości zamocowanego elementu **B** na korpusie / ramie.



ACHTUNG - Stellen Sie die Höhe des Befestigungselements **A** am Kopfteil zu einer Höhe von Element **B** montiert auf dem Körper / Rahmen.

CAUTION - Adjust the height of fixing the element **A** at the headboard to the height of the element **B** at the frame.

OK

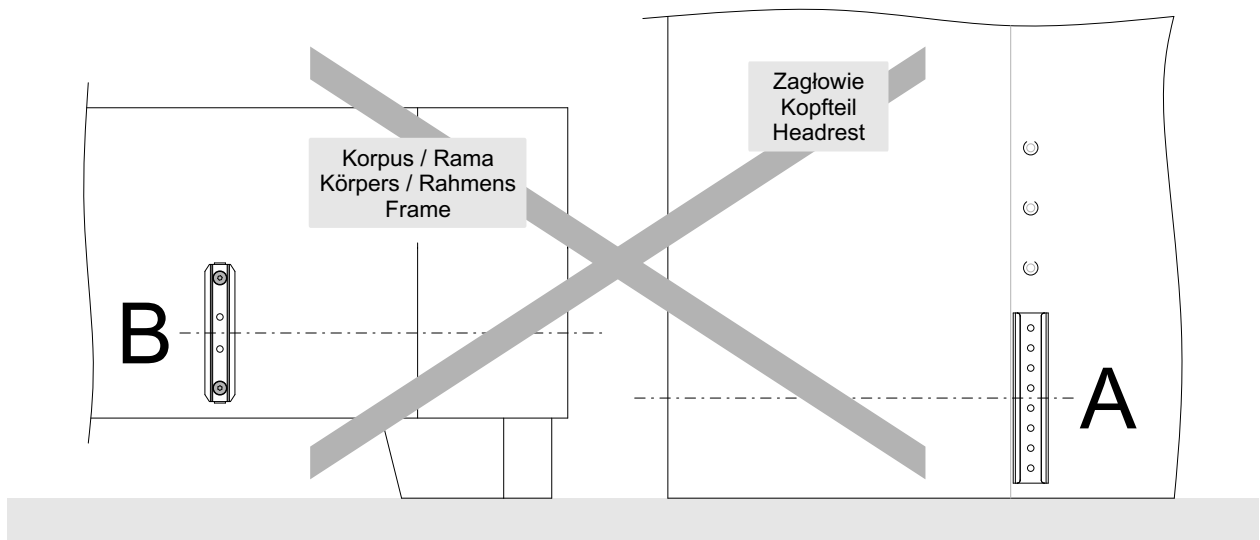
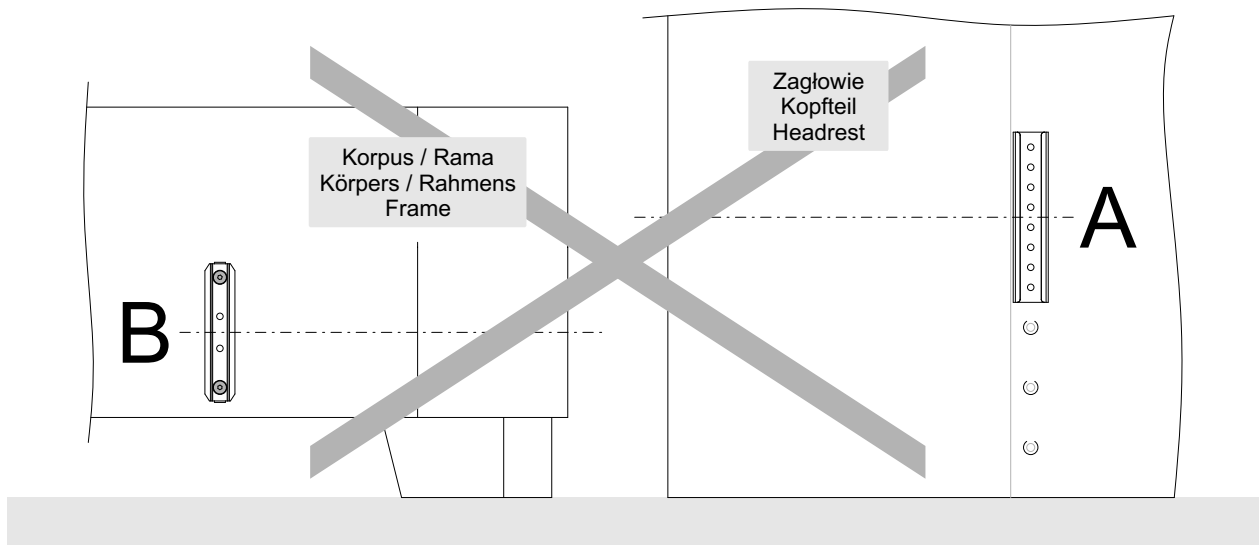
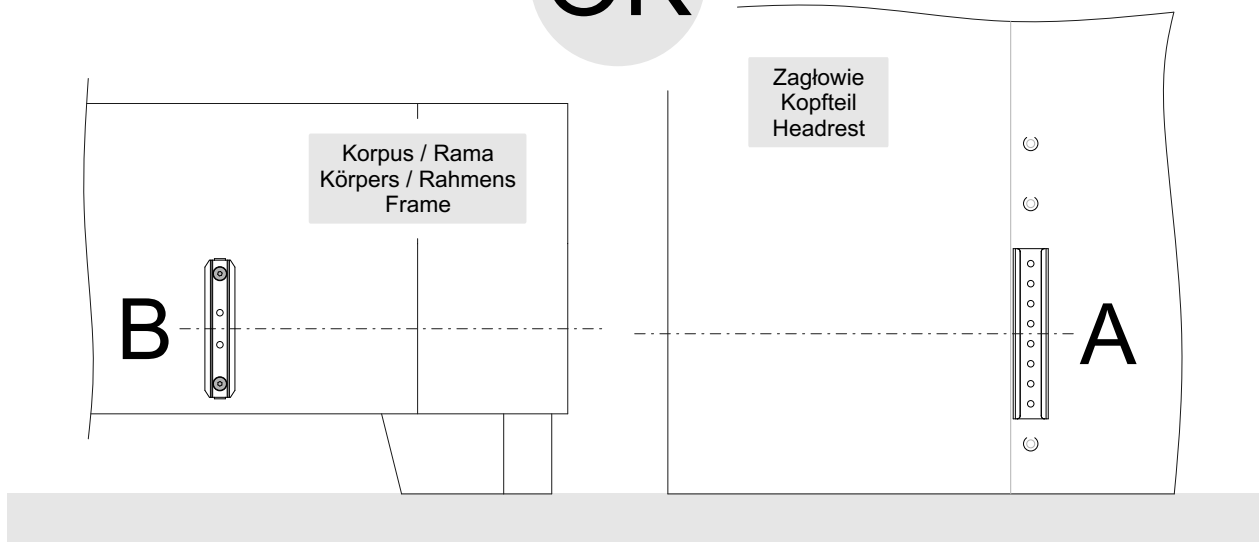

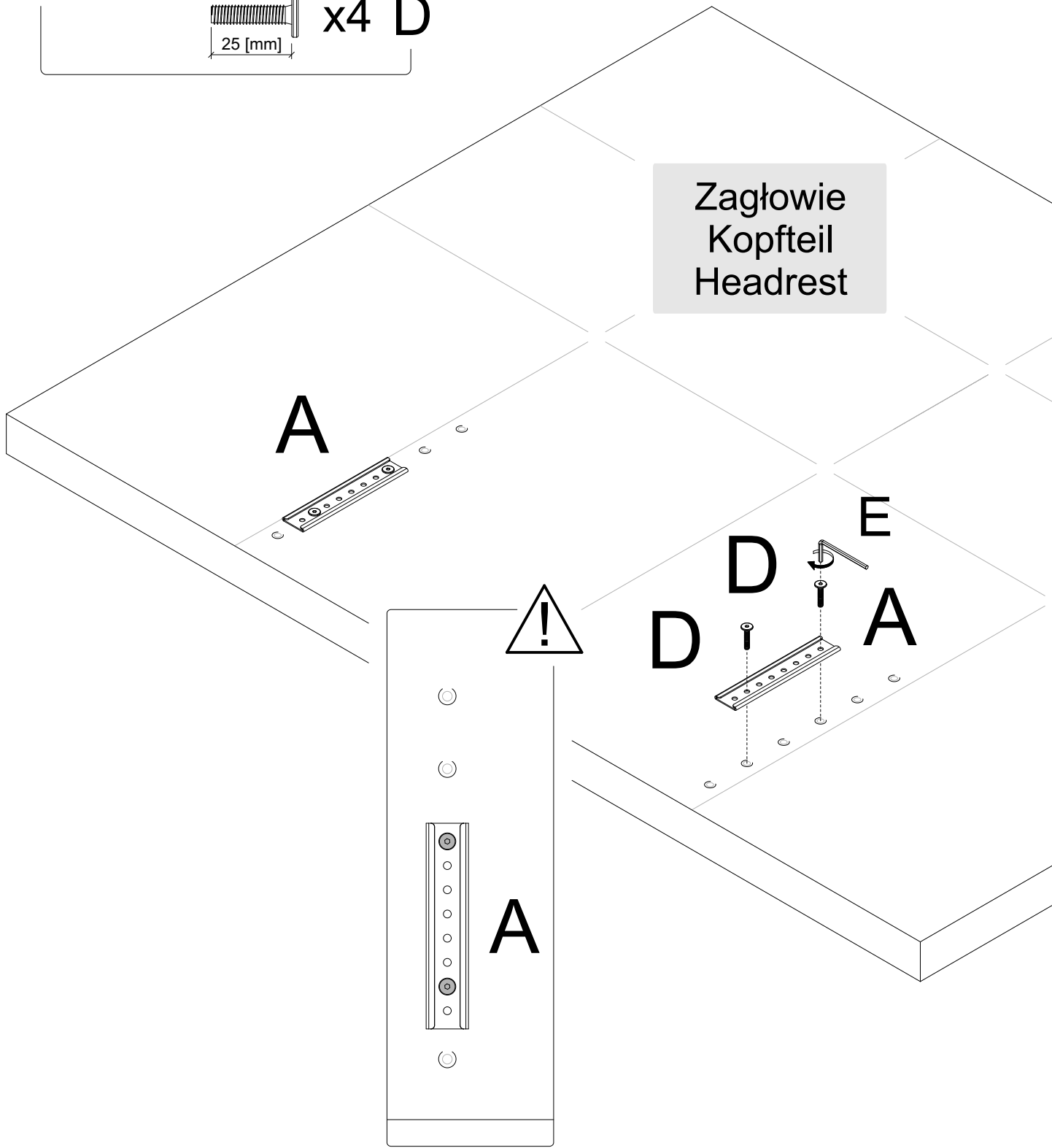
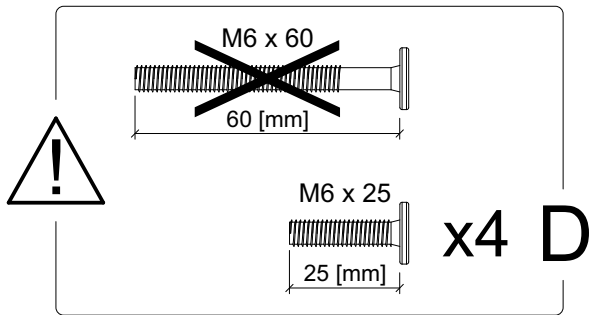

Skala / Scale 1:1

