

(PL) Instrukcja montażu  
 (D) Aufbauanleitung  
 (GB) Assembly instruction  
 (SK) Návod na montáž

# ZW / ZM / ZS

(08-10)

**materace**

M&K foam GmbH Sp z o.o.  
 ul. Toruńska 267  
 62-600 Koło  
 Tel. 0048 63 2624300  
 Fax 0048 63 2616118  
 www.mkfoam.pl



Kretschmar GmbH  
 Rudolf - Diesel - Weg 10  
 30419 Hannover  
 Tel. 0049 511 96605540  
 Fax 0049 511 96605599

**UWAGA**

Drogi kliencie, przed rozpoczęciem montażu upewnij się, czy posiadasz wszystkie niezbędne elementy pokazane na instrukcji.

W przypadku domówienia mebla tapicerowanego tkaniną w takim samym kolorze jak zakupione wcześniej meble, może wystąpić różnica w odcieniach wybranej tkaniny.

**ACHTUNG**

Sehr geehrter Kunde. Bitte überprüfen Sie vor Beginn der Montage die Vollständigkeit unten aufgeführten Bauteile. Bei einer Nachbestellung dieser Artikel können Farbabweichungen bei den gewebten Stoffen sein.

**CAUTION**

Dear Customer, before assembly, ensure that you have all the necessary elements specified in the instruction. In case of ordering the same fabric in different time, the colour of fabric may be a little bit different.

**POZOR**

Vážený zákazník, pred montážou sa prosíme uistiť či v balení sú všetky potrebné diely znázornené v návode.

V prípade objednania textilie čalúnený nábytok v rovnakej farbe ako predtým zakúpeného nábytku, môže byť rozdiel v odtieňoch zvolenej látky.

Oznaczenia kontrolne  
 Bezeichnungen steuern  
 Control marks  
 Označenie ovládat'





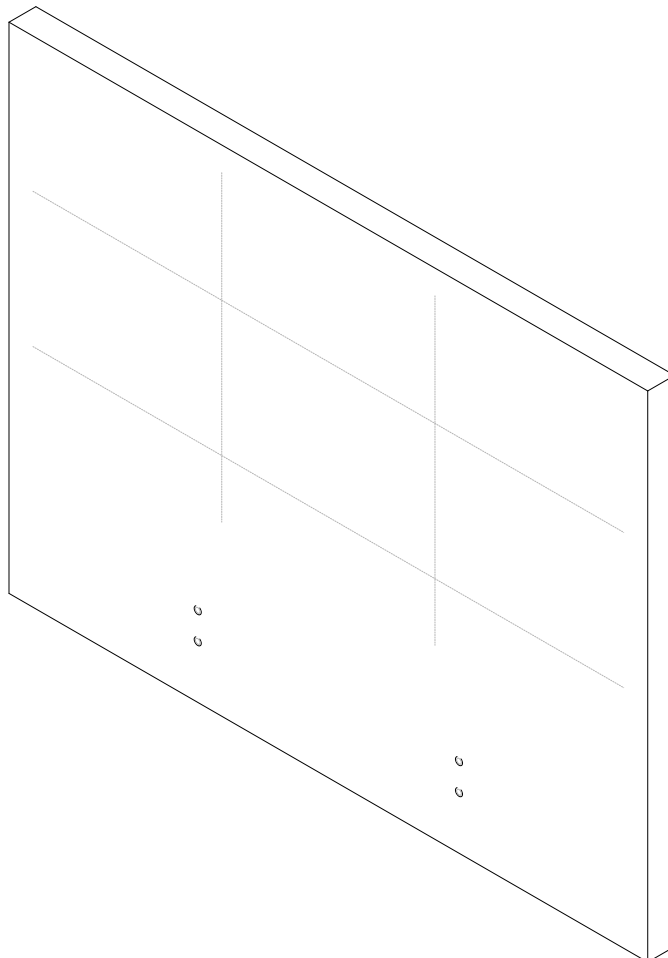

Elementy w paczkach  
 Befestigungsmaterial im Paket  
 Items in the packages  
 Položky v balení



Nr	Indeks	Szt.
1	X-ZW.....-..... lub	1
	X-ZM.....-..... lub	
	X-ZS.....-.....	

Elementy w worku serwisowym  
 Befestigungsmaterial im Servicebeutel  
 Items in bag service  
 Položky v sáčku služby

X\_ZS-WSM

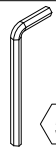
A	B	C	D	E
				
M8 x 80	M8 x 100	M10x30x2,5	M8	5
2 x	2 x	2 x	2 x	1 x

Dodatkowe elementy niezbędne do sprawnego montażu  
 Zusätzliche Komponenten für eine reibungslose Installation  
 Additional components needed for a smooth assembly  
 Ďalšie komponenty potrebné pre správny inštaláciu

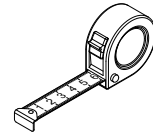
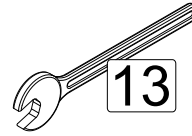



**Instrukcja montażu - Aufbauanleitung - Assembly instruction - Návod na montáž**

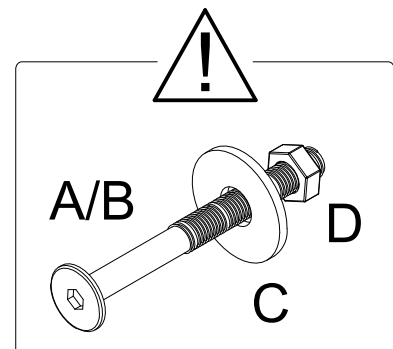
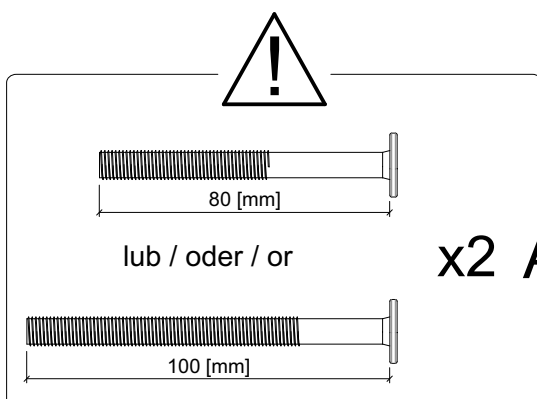
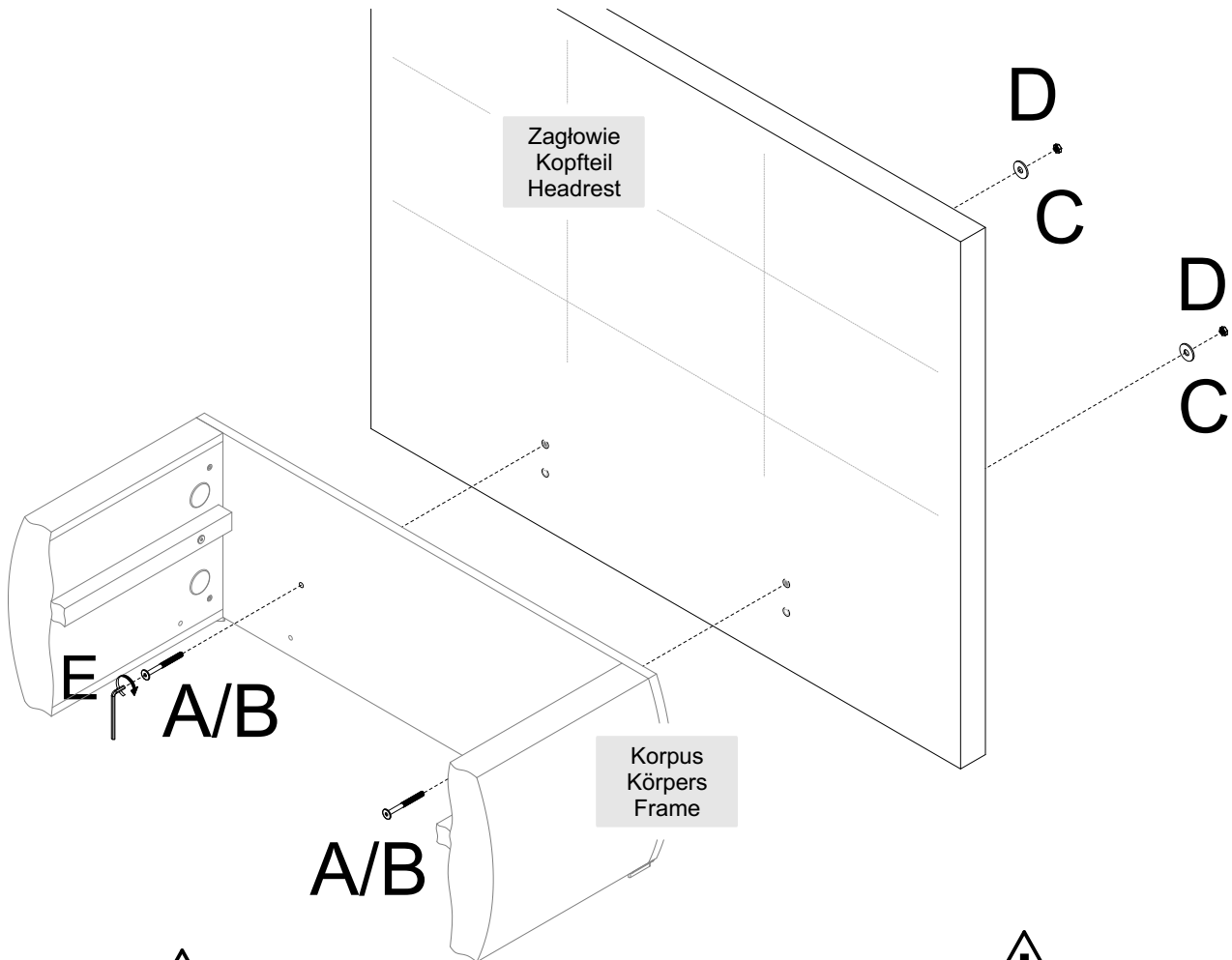

Montaż zagłówka do:  
 Montage der Kopfteil in:  
 Mounting the headrest to:  
 Montáž opierku hlavy do:

**KBK / KBO / KBRM / KBS / KB2 / KKF / KRA / KRM  
 KSD / KSRM / KSZ / KSV / KWRM / TIK / TIKS**



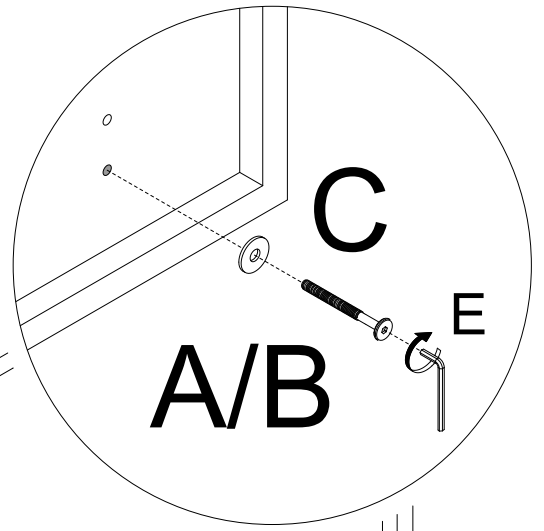
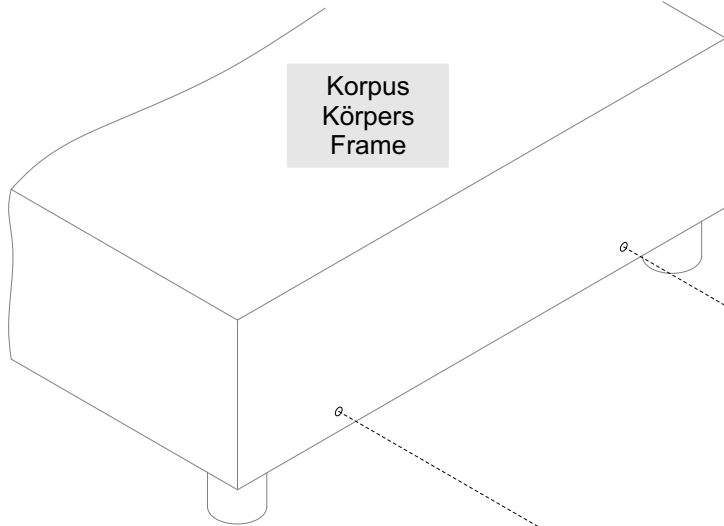

 Montaż zagłówka do:  
 Montage der Kopfteil in:  
 Mounting the headrest to:  
 Montáž opierku hlavy do:

**KPO**

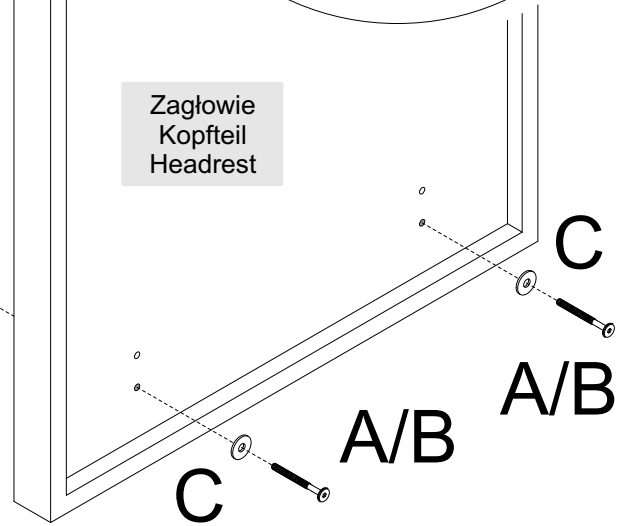

Zagłowie  
Kopfteil  
Headrest



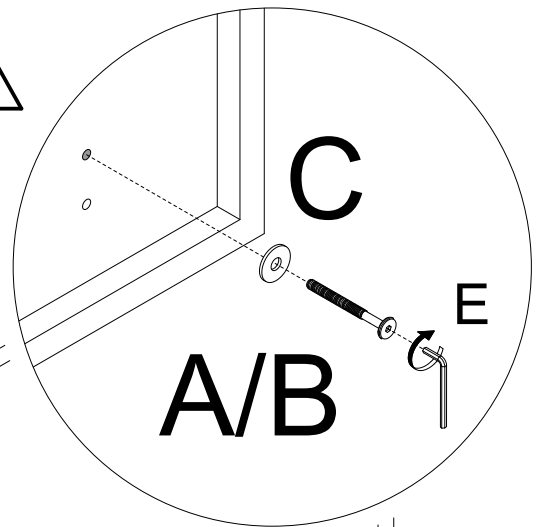
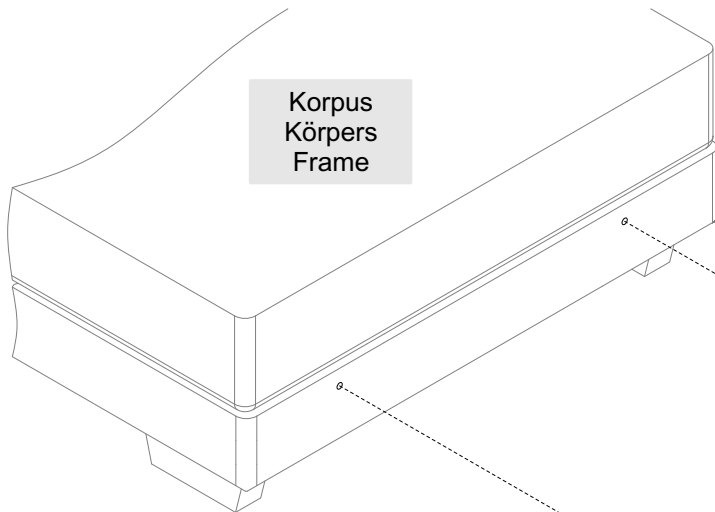

 Montaż zagłówka do:  
 Montage der Kopfteil in:  
 Mounting the headrest to:  
 Montáž opierku hlavy do:

**KE (Korpus Electro)  
KP2**

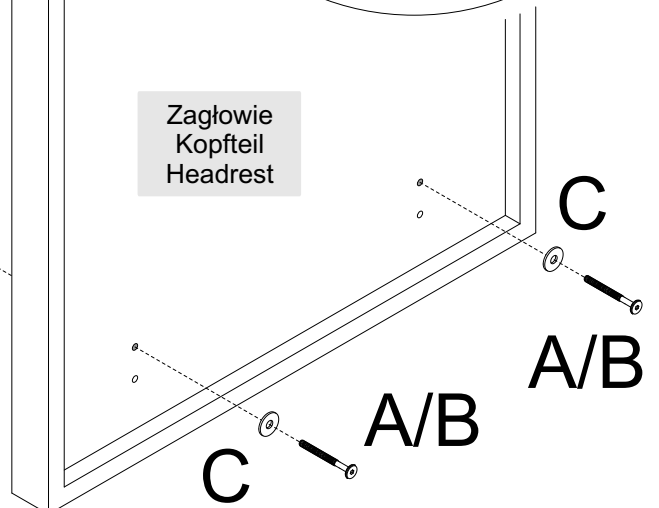

Zagłowie  
Kopfteil  
Headrest





Montaż zagłówka do:  
 Montage der Kopfteil in:  
 Mounting the headrest to:  
 Montáž opierku hlavy do:

**KSS**

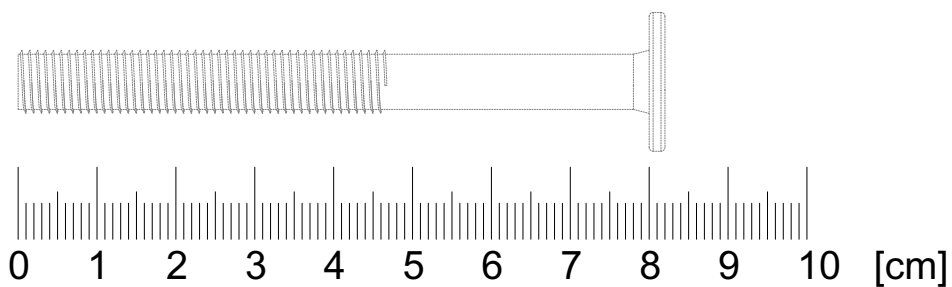
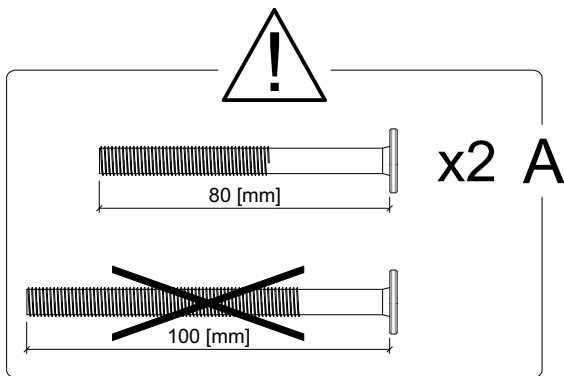
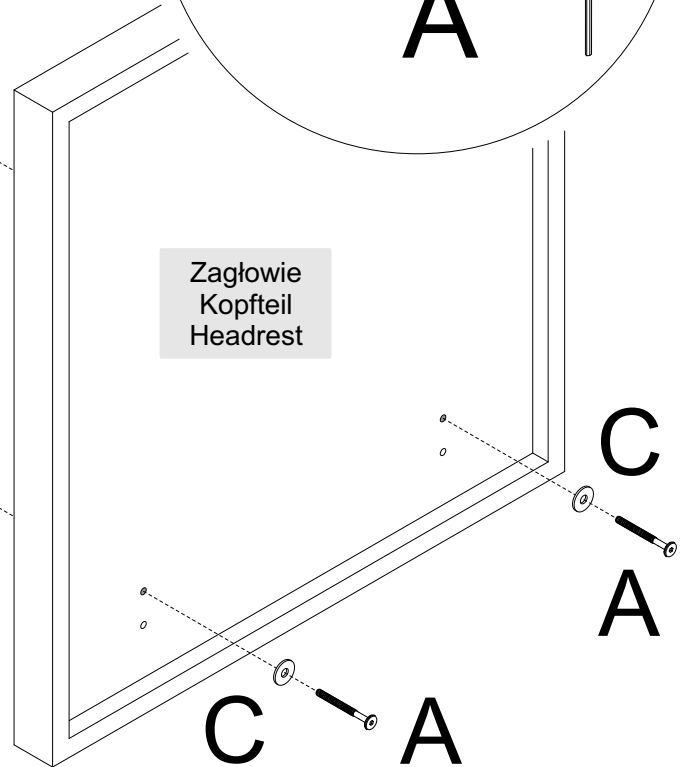
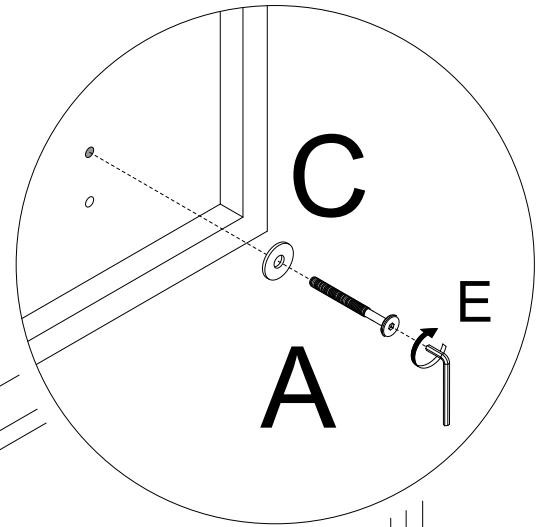
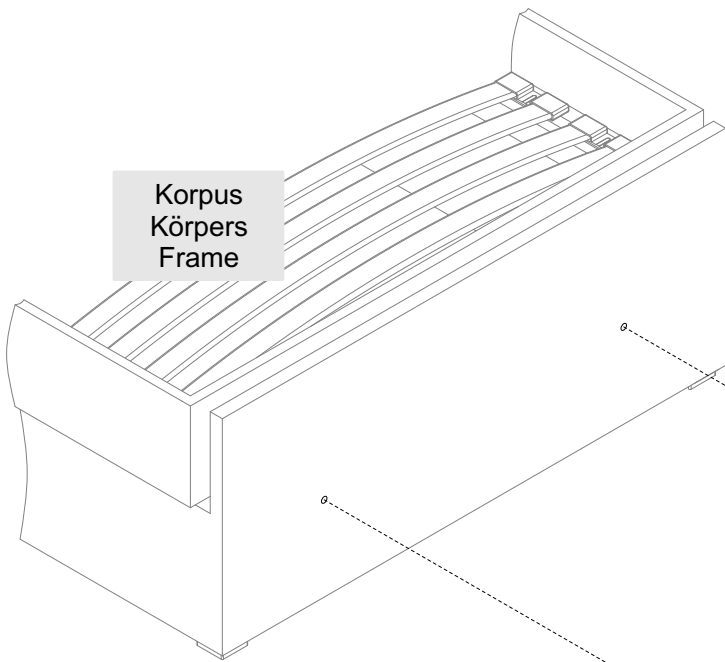

Skala / Scale 1:1